

S3M0040120D

1200V SiC POWER MOSFET

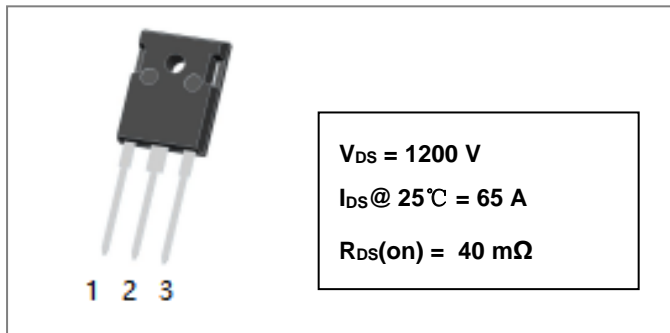

Description

S3M0040120D is a single SiC Power MOSFET packaged in TO-247-3 case. The device is a high voltage n-channel Enhancement mode MOSFET that has very low total conduction losses and very stable switching characteristics over temperature extremes. The S3M0040120D is ideal for energy sensitive, high frequency applications in challenging environments.

Circuit Diagram

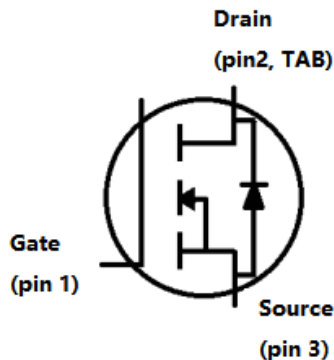

Features

- Positive temperature characteristics, easy to parallel.
- Low on-resistance typ. $R_{DS(on)} = 40\text{m}\Omega$.
- Fast switching speed and low switching losses.
- Very fast and robust intrinsic body diode.
- Process of non-bright tin electroplating
- “-A” is an AEC-Q101 qualified device

Applications

- EV Fast Charging Modules
- EV On-Board Chargers
- Solar Inverters
- Online UPS/Industrial UPS
- SMPS (Switch Mode Power Supplies)
- DC-DC Converters
- ESS (Energy Storage Systems)

Maximum Ratings ($T_A = 25\text{ }^\circ\text{C}$, unless otherwise specified)

Characteristics	Symbol	Conditions	Min.	Typ.	Max.	Units	Note
Drain - Source Voltage	V_{DSmax}	$V_{GS} = 0\text{ V}$, $I_D = 100\text{ }\mu\text{A}$			1200	V	
Gate - Source Voltage (dynamic)	V_{GSmax}	AC ($f > 1\text{ Hz}$)	-8		+20	V	
Gate - Source Voltage (static)	V_{GSop}	Static		-4 / +18		V	[1]
Continuous Drain Current	I_D	$V_{GS} = 18\text{ V}$, $T_C = 25\text{ }^\circ\text{C}$			65	A	
		$V_{GS} = 18\text{ V}$, $T_C = 100\text{ }^\circ\text{C}$			46		
Pulsed Drain Current	$I_{D(pulse)}$	Pulse width t_P limited by T_{jmax}			223	A	
Power Dissipation	P_D	$T_C = 25\text{ }^\circ\text{C}$			130	W	

[1] Recommended turn off gate voltage is -4 V. Recommended turn on gate voltage is 18 V. Do not use with $V_{GSon} < 12\text{ V}$.

Electrical Characteristics ($T_A = 25\text{ }^\circ\text{C}$, unless otherwise specified)

Characteristics	Symbol	Conditions	Min.	Typ.	Max.	Units
Drain Source Breakdown Voltage	$V_{(BR)DSS}$	$V_{GS} = 0\text{ V}$, $I_D = 100\text{ }\mu\text{A}$	1200			V
Gate Threshold Voltage	$V_{GS(th)}$	$V_{DS} = V_{GS}$, $I_D = 16\text{ mA}$	2	2.5	4	V
		$V_{DS} = V_{GS}$, $I_D = 16\text{ mA}$, $T_J = 175\text{ }^\circ\text{C}$		1.7		V
Zero Gate Voltage Drain Current	I_{DSS}	$V_{DS} = 1200\text{ V}$, $V_{GS} = 0\text{ V}$		1	100	μA
Gate Source Leakage Current	I_{GSS}	$V_{GS} = 18\text{ V}$, $V_{DS} = 0\text{ V}$		10	250	nA
Drain Source On-State Resistance	$R_{DS(on)}$	$V_{GS} = 18\text{ V}$, $I_D = 40\text{ A}$		40	52	m Ω
		$V_{GS} = 18\text{ V}$, $I_D = 40\text{ A}$, $T_J = 175\text{ }^\circ\text{C}$		50		m Ω
Transconductance	gfs	$V_{DS} = 20\text{ V}$, $I_{DS} = 40\text{ A}$		18		S
		$V_{DS} = 20\text{ V}$, $I_{DS} = 40\text{ A}$, $T_J = 175\text{ }^\circ\text{C}$		19		S
Input Capacitance	C_{ISS}	$V_{GS} = 0\text{ V}$		2844		pF
Output Capacitance	C_{OSS}	$V_{DS} = 1000\text{ V}$		134		
Reverse Transfer Capacitance	C_{RSS}	$V_{AC} = 25\text{ mV}$		17		
C_{OSS} Stored Energy	E_{OSS}	$f = 1\text{ MHz}$		78		
Turn-On Switching Energy	E_{ON}	$V_{DS} = 800\text{ V}$, $V_{GS} = -4 / 18\text{ V}$		212		μJ
Turn-Off Switching Energy	E_{OFF}	$I_D = 40\text{ A}$, $R_{G(ext)} = 2.5\text{ }\Omega$, $L = 99\text{ }\mu\text{H}$		198		
Turn-On Delay Time	$t_{d(on)}$	$V_{DS} = 800\text{ V}$, $V_{GS} = -4 / 18\text{ V}$		12.5		ns
Rise Time	t_r	$I_D = 40\text{ A}$, $R_{G(ext)} = 2.5\text{ }\Omega$		14.7		

Technical Data
Data Sheet N2817, REV.-

RoHS

Turn-Off Delay Time	$t_{d(off)}$	Inductive Load Timing relative to VDS Per IEC60747-8-4 pg 83	27.5		
Fall Time	t_f		7.0		
Internal Gate Resistance	$R_{G(int)}$	$f = 1 \text{ MHz}, AC = 25 \text{ mV}$	1.3		Ω
Gate to Source Charge	Q_{gs}	$V_{DS} = 800 \text{ V}, V_{GS} = -4 / 18 \text{ V}$ $I_D = 40 \text{ A}$ Per IEC60747-8-4 pg 21	66		nC
Gate to Drain Charge	Q_{gd}		49		
Total Gate Charge	Q_g		143		

Reverse Diode Characteristics ($T_A = 25 \text{ }^\circ\text{C}$, unless otherwise specified)

Characteristics	Symbol	Conditions	Typ.	Max.	Units
Diode Forward Voltage	V_{SD}	$V_{GS} = -4 \text{ V}, I_{SD} = 20 \text{ A}$	4.3		V
	V_{SD}	$V_{GS} = -4 \text{ V}, I_{SD} = 20 \text{ A}, T_J = 175^\circ\text{C}$	3.6		V
Continuous Diode Forward Current	I_S	$V_{GS} = -4 \text{ V}, T_C = 25 \text{ }^\circ\text{C}$	48		A
Reverse Recovery Time	t_{rr}	$V_{GS} = -4 \text{ V}, I_{SD} = 40 \text{ A}, T_J = 25 \text{ }^\circ\text{C}$ $V_R = 800\text{V}$ $dif / dt = 3000 \text{ A} / \mu\text{s}$	16		ns
Reverse Recovery Charge	Q_{rr}		221		nC
Peak Reverse Recovery Current	I_{mm}		23		A

Thermal-Mechanical Specifications

Characteristics	Symbol	Condition	Specification	Units
Junction Temperature	T_J	-	-55 to +175	°C
Storage Temperature	T_{stg}	-	-55 to +175	°C
Typical Thermal Resistance Junction to Case	$R_{\theta JC}$	DC operation	0.31	°C/W

Ordering Information

Device	Package	Shipping
S3M0040120D	TO-247-3	30pcs/tube

Marking Diagram

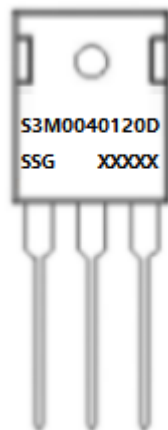

Where XXXXX is YYWWL

S3M = Device Type
0040 = R_{bs(on)}
120 = Reverse Voltage (1200V)
D = Package
SSG = SSG
YY = Year
WW = Week
L = Lot Number

Cautions: Molding resin
Epoxy resin UL:94V-0

Ratings and Characteristics Curves

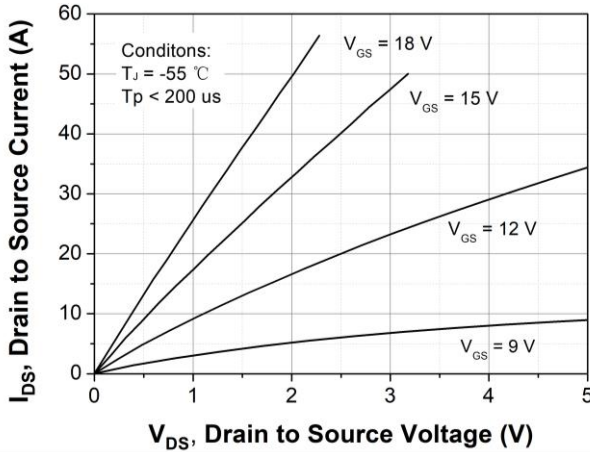

Figure 1. Output Characteristics $T_J = -55\text{ }^\circ\text{C}$

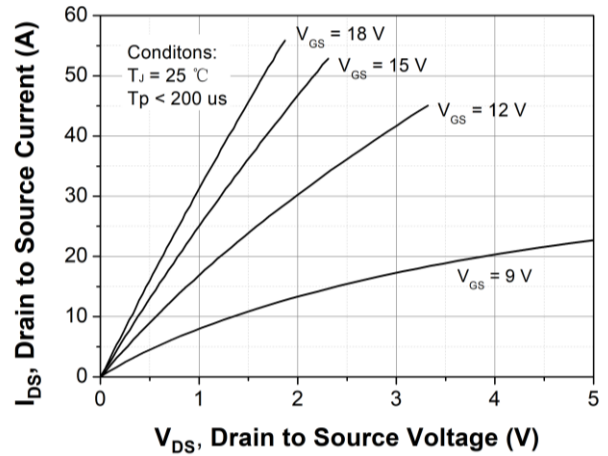

Figure 2. Output Characteristics $T_J = 25\text{ }^\circ\text{C}$

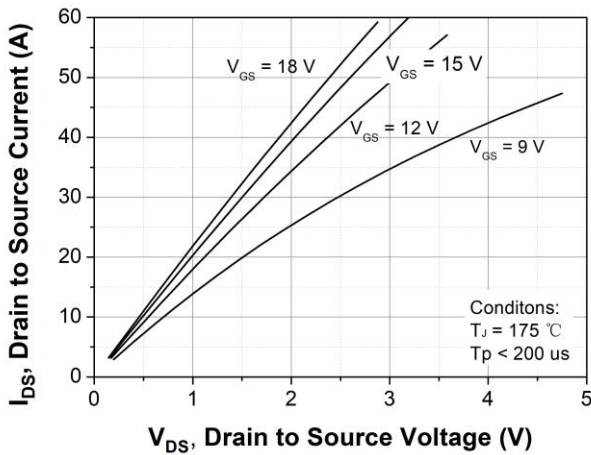

Figure 3. Output Characteristics $T_J = 175\text{ }^\circ\text{C}$

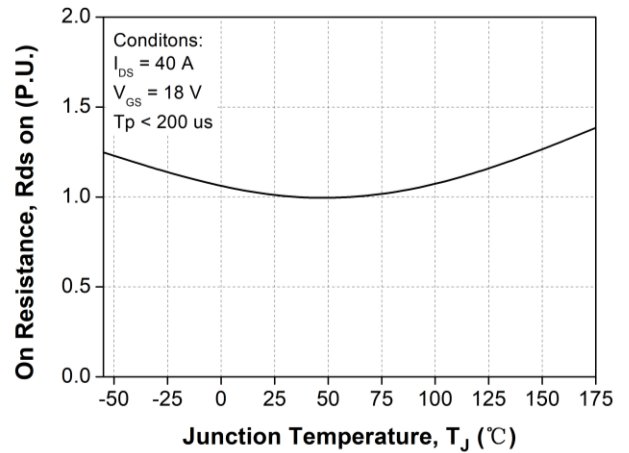

Figure 4. Normalized On-Resistance vs. Temperature

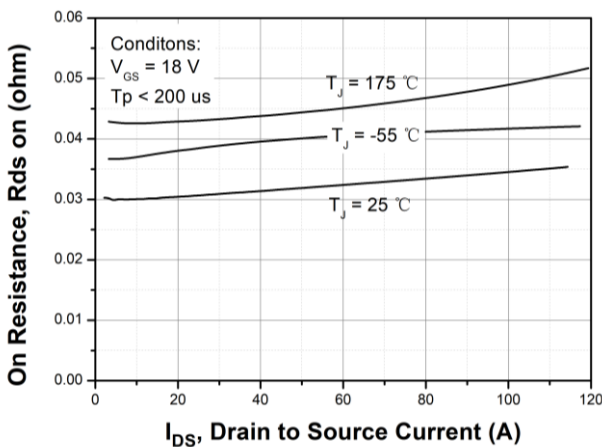

Figure 5. On-Resistance vs. Drain Current For Various Temperatures

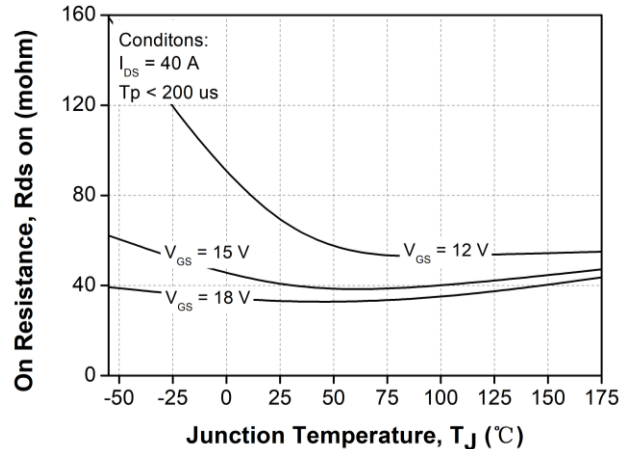

Figure 6. On-Resistance vs. Temperature For Various Gate Voltage

Technical Data
Data Sheet N2817, REV.-

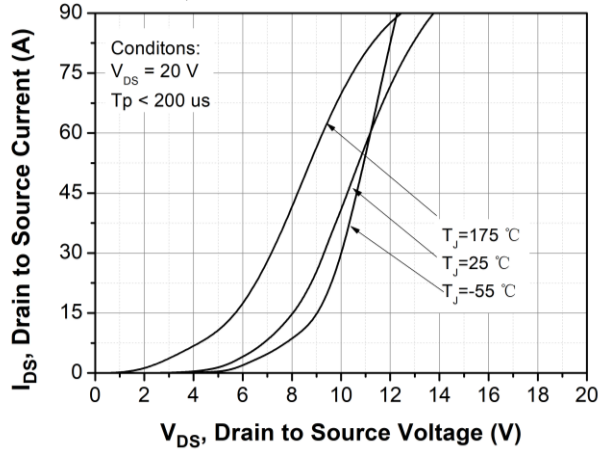

Figure 7. Transfer Characteristic for Various Junction Temperatures

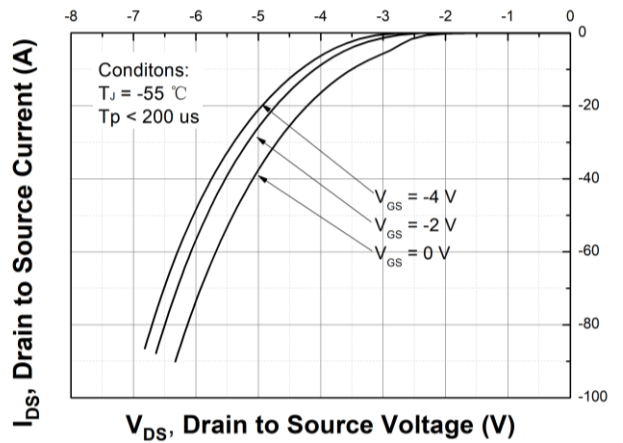

Figure 8. Body Diode Characteristic at $T_J = -55\text{ }^\circ\text{C}$

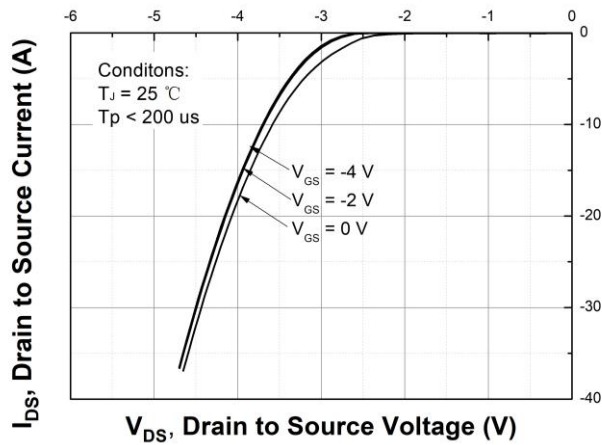

Figure 9. Body Diode Characteristic at $T_J = 25\text{ }^\circ\text{C}$

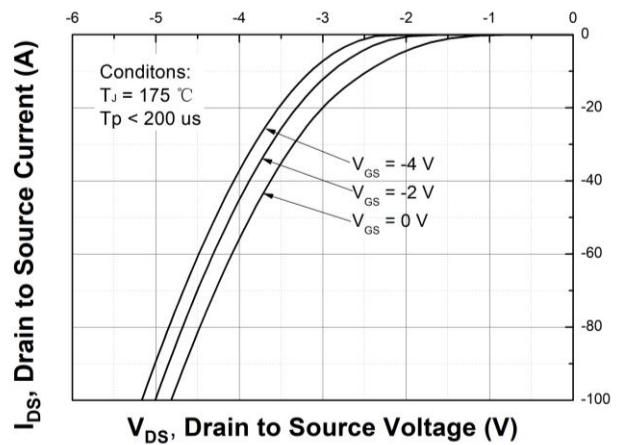

Figure 10. Body Diode Characteristic at $T_J = 175\text{ }^\circ\text{C}$

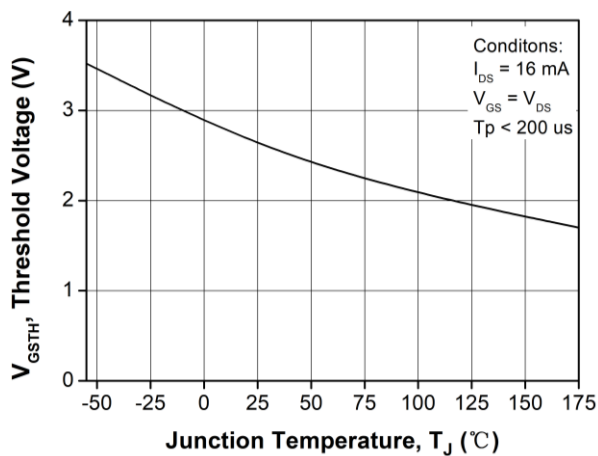

Figure 11. Threshold Voltage vs. Temperature

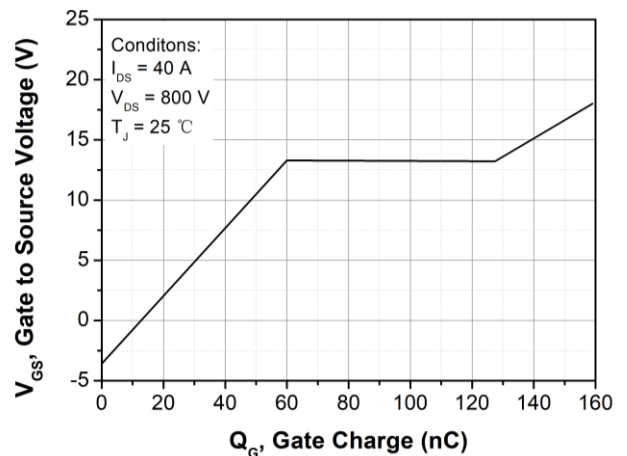

Figure 12. Gate Charge Characteristic

Technical Data
Data Sheet N2817, REV.-

RoHS

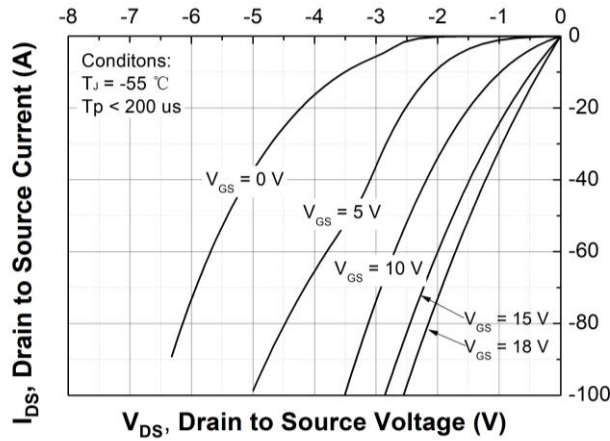

Figure 13. 3rd Quadrant Characteristic at $T_J = -55\text{ }^\circ\text{C}$

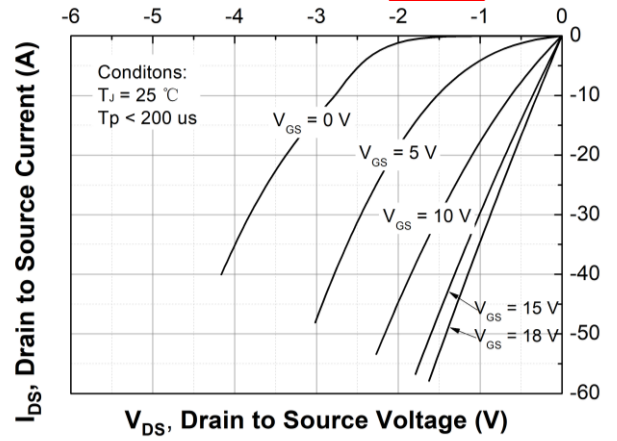

Figure 14. 3rd Quadrant Characteristic at $T_J = 25\text{ }^\circ\text{C}$

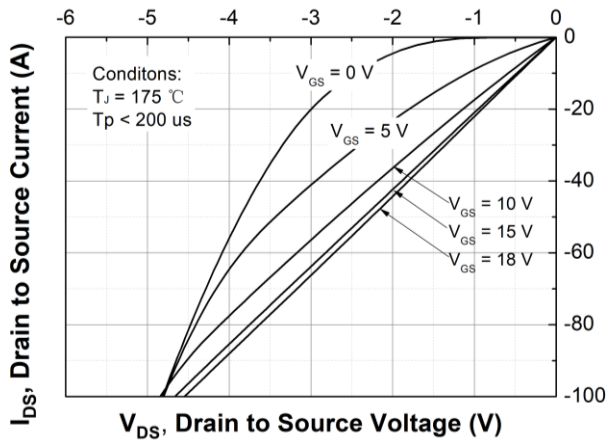

Figure 15. 3rd Quadrant Characteristic at $T_J = 175\text{ }^\circ\text{C}$

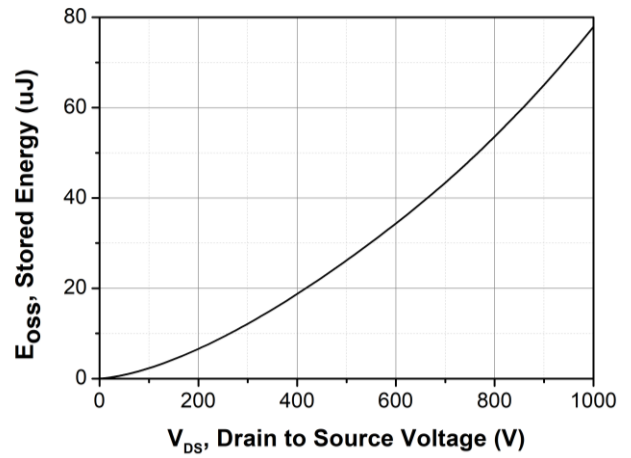

Figure 16. Output Capacitor Stored Energy

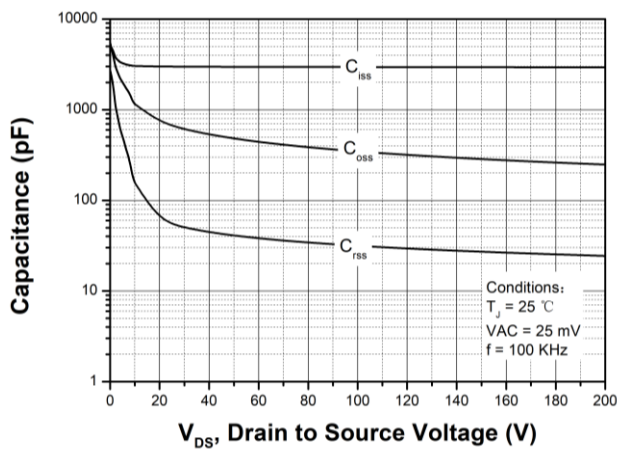

Figure 17. Capacitances vs. Drain-Source Voltage (0 - 200 V)

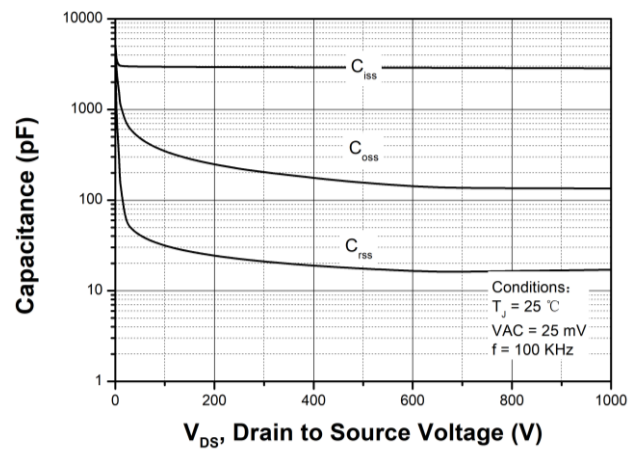

Figure 18. Capacitances vs. Drain-Source Voltage (0 - 1000 V)

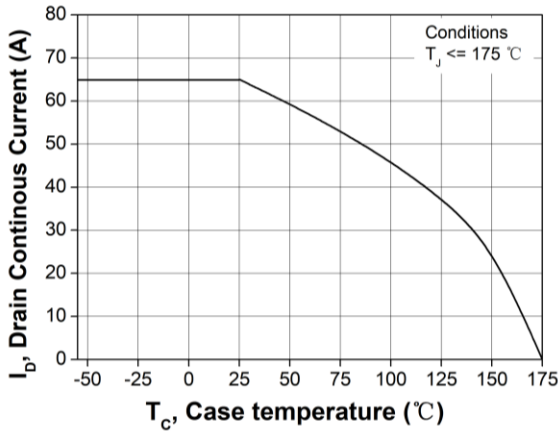

Figure 19. Continuous Drain Current Derating vs. Case Temperature

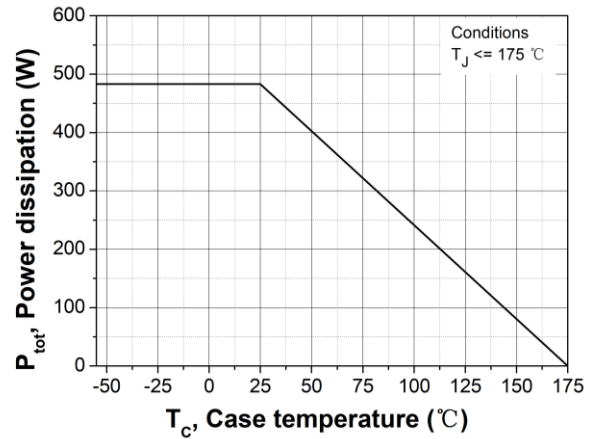

Figure 20. Maximum Power Dissipation Derating vs. Case Temperature

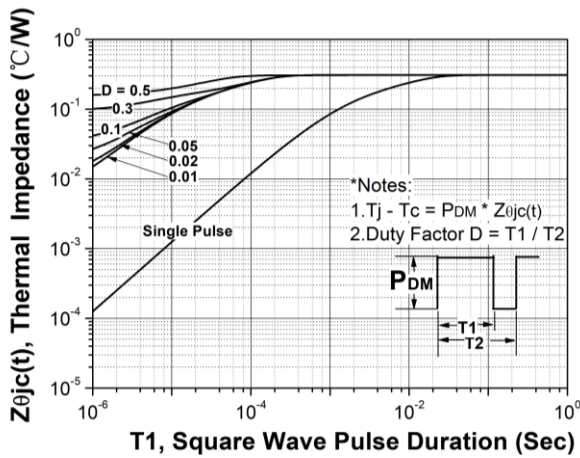

Figure 21. Transient Thermal Impedance (Junction - Case)

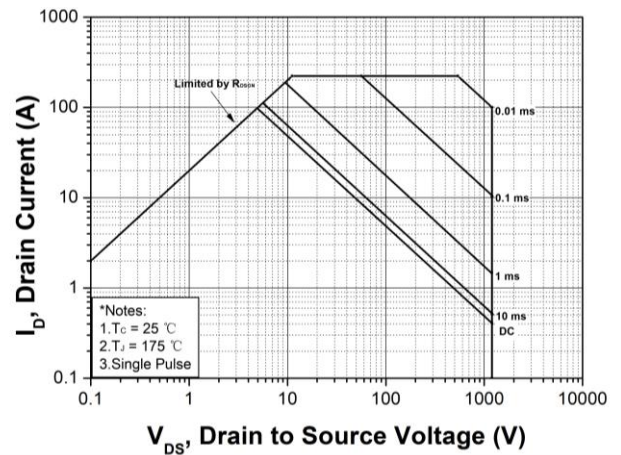

Figure 22. Safe Operating Area

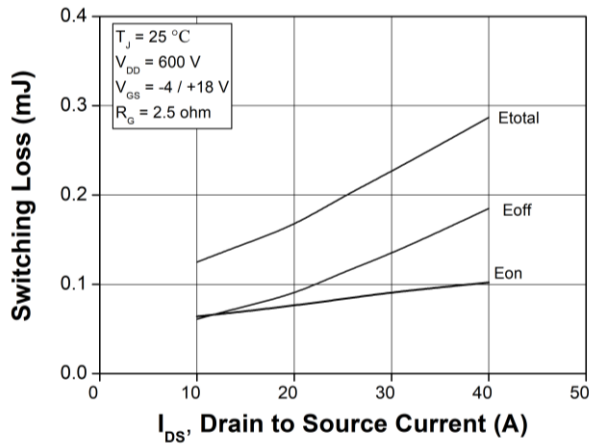

Figure 23. Clamped Inductive Switching Energy vs. Drain Current ($V_{DD} = 600V$)

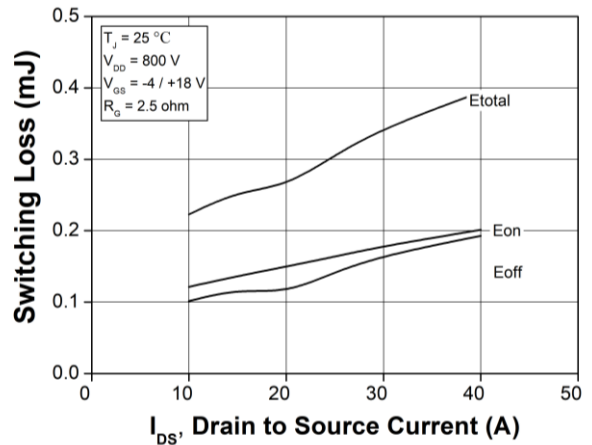

Figure 24. Clamped Inductive Switching Energy vs. Drain Current ($V_{DD} = 800V$)

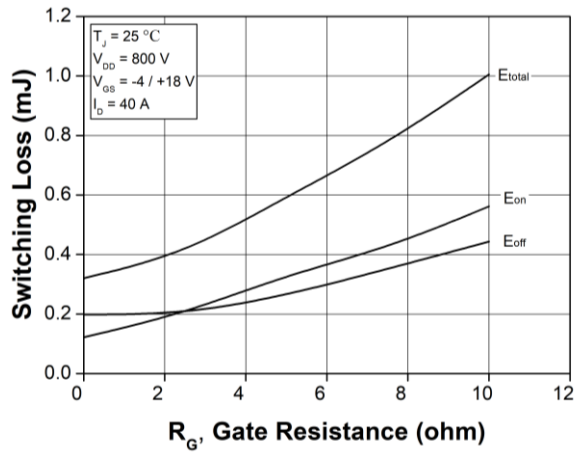

Figure 25. Clamped Inductive Switching Energy vs. R_{G(ext)}

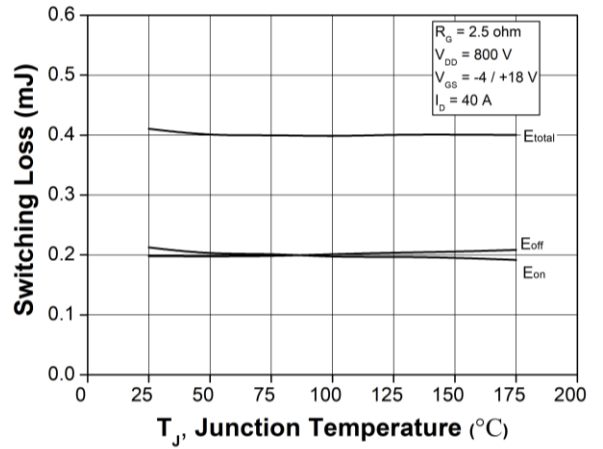

Figure 26. Clamped Inductive Switching Energy vs. Temperature

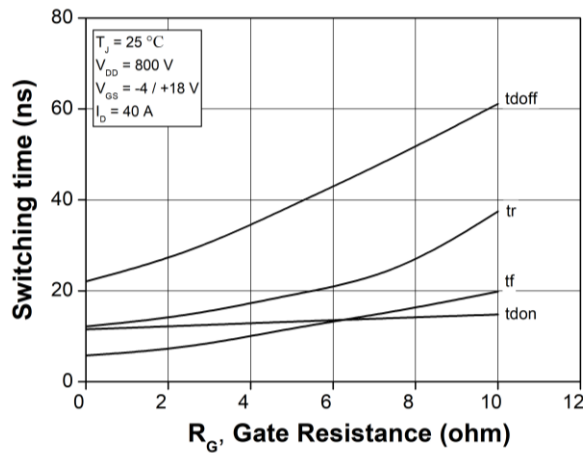

Figure 27. Switching Times vs. R_{G(ext)}

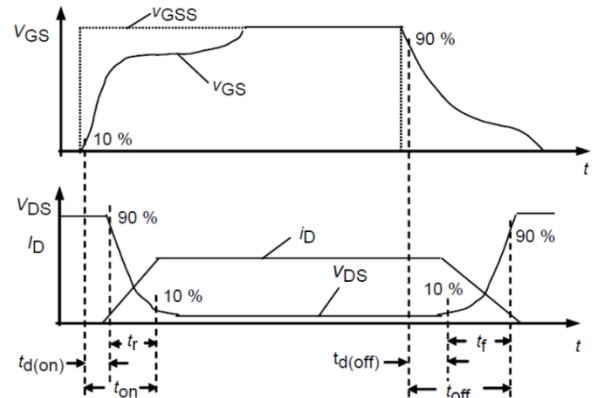
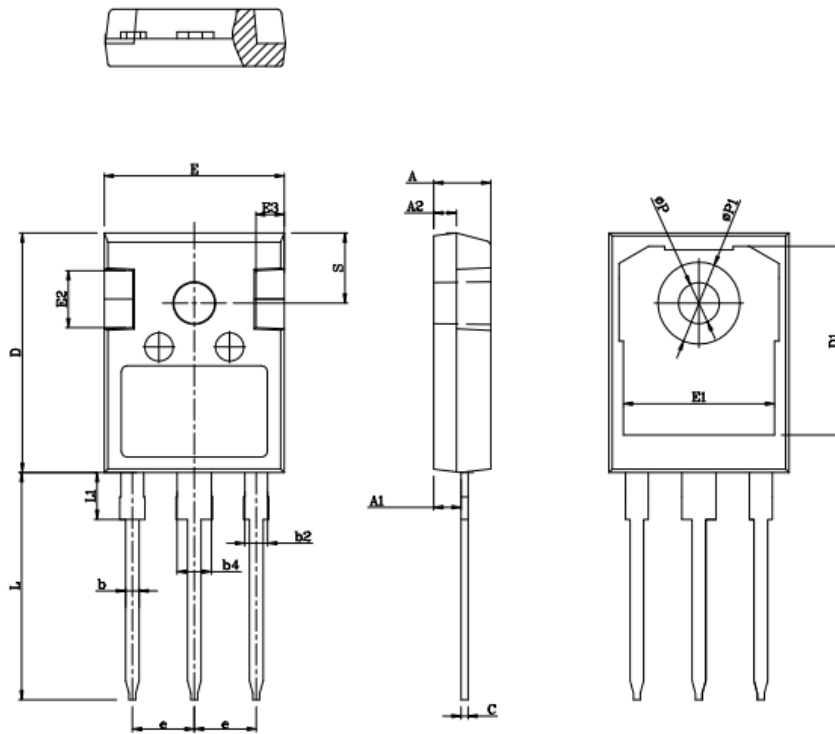

Figure 28. Switching Times Definition

Mechanical Dimensions TO-247-3



COMMON DIMENSIONS

SYMBOL	mm		
	Min	Nom	Max
A	4.80	5.00	5.20
A1	2.23	2.41	2.59
A2	1.85	2.00	2.15
b	1.11	1.21	1.36
b2	1.91	2.01	2.21
b4	2.91	3.01	3.21
c	0.51	0.61	0.75
D	20.80	21.00	21.30
D1	16.25	16.55	16.85
E	15.50	15.80	16.10
E1	13.00	13.26	13.56
E2	4.80	5.00	5.20
E3	2.30	2.50	2.70
e	5.44BSC		
L	19.82	19.92	20.22
L1	3.94	4.12	4.30
ØP	3.40	3.60	3.80
ØP1	7.08	7.19	7.30
S	6.15BSC		



S3M0040120D

Technical Data
Data Sheet N2817, REV.-

RoHS

DISCLAIMER:

- 1- The information given herein, including the specifications and dimensions, is subject to change without prior notice to improve product characteristics. Before ordering, purchasers are advised to contact the SMC Diode Solutions sales department for the latest version of the datasheet(s).
- 2- In cases where extremely high reliability is required (such as use in nuclear power control, aerospace and aviation, traffic equipment, medical equipment, and safety equipment), safety should be ensured by using semiconductor devices that feature assured safety or by means of users' fail-safe precautions or other arrangement.
- 3- In no event shall SMC Diode Solutions be liable for any damages that may result from an accident or any other cause during operation of the user's units according to the datasheet(s). SMC Diode Solution assumes no responsibility for any intellectual property claims or any other problems that may result from applications of information, products or circuits described in the datasheets.
- 4- In no event shall SMC Diode Solutions be liable for any failure in a semiconductor device or any secondary damage resulting from use at a value exceeding the absolute maximum rating.
- 5- No license is granted by the datasheet(s) under any patents or other rights of any third party or SMC Diode Solutions.
- 6- The datasheet(s) may not be reproduced or duplicated, in any form, in whole or part, without the expressed written permission of SMC Diode Solutions.
- 7- The products (technologies) described in the datasheet(s) are not to be provided to any party whose purpose in their application will hinder maintenance of international peace and safety nor are they to be applied to that purpose by their direct purchasers or any third party. When exporting these products (technologies), the necessary procedures are to be taken in accordance with related laws and regulations..